

Power & Energy Logger Models PEL 102 & PEL 103



POWER & ENERGY LOGGERS

Copyright© Chauvin Arnoux®, Inc. d.b.a. AEMC® Instruments. All rights reserved.

No part of this documentation may be reproduced in any form or by any means (including electronic storage and retrieval or translation into any other language) without prior agreement and written consent from Chauvin Arnoux®, Inc., as governed by United States and International copyright laws.

Chauvin Arnoux®, Inc. d.b.a. AEMC® Instruments
15 Faraday Drive • Dover, NH 03820 USA
Tel: (800) 945-2362 or (603) 749-6434 • Fax: (603) 742-2346

This documentation is provided “as is,” without warranty of any kind, express, implied, or otherwise. Chauvin Arnoux®, Inc. has made every reasonable effort to ensure that this documentation is accurate; but does not warrant the accuracy or completeness of the text, graphics, or other information contained in this documentation. Chauvin Arnoux®, Inc. shall not be liable for any damages, special, indirect, incidental, or inconsequential; including (but not limited to) physical, emotional or monetary damages due to lost revenues or lost profits that may result from the use of this documentation, whether or not the user of the documentation has been advised of the possibility of such damages.

Statement of Compliance

Chauvin Arnoux®, Inc. d.b.a. AEMC® Instruments certifies that this instrument has been calibrated using standards and instruments traceable to international standards.

We guarantee that at the time of shipping your instrument has met the instrument's published specifications.

An NIST traceable certificate may be requested at the time of purchase, or obtained by returning the instrument to our repair and calibration facility, for a nominal charge.

The recommended calibration interval for this instrument is 12 months and begins on the date of receipt by the customer. For recalibration, please use our calibration services. Refer to our repair and calibration section at www.aemc.com/calibration.

Serial #: _____

Catalog #: 2137.51 / 2137.52 / 2137.61 / 2137.62

Model #: PEL 102 / PEL 103

Please fill in the appropriate date as indicated:

Date Received: _____

Date Calibration Due: _____



Chauvin Arnoux®, Inc.
d.b.a AEMC® Instruments
www.aemc.com

PRODUCT PACKAGING

Shipping Contents:



(1) Small Classic Tool Bag
Cat. #2133.72

(1) of the following:

Power & Energy Logger Model PEL 102

Power & Energy Logger Model PEL 103

Cat. #2137.51 / 2137.52 / 2137.61 / 2137.62



(3) MiniFlex® MA193-10-BK
Cat. #2140.48

*(included only with
the purchase of*

Cat. #2137.51 or Cat. #2137.52)



(4) Black Test Leads and
Alligator Clips
Cat. #2140.44



(1) USB SD-Card Adapter
Cat. #5000.45



(1) 4 GB USB Drive
with User Manual &
Dataview® Software



(1) Power Cord
Cat. #5000.14



(1) 5 ft USB Cable
Cat. #2140.46

Also Included:

(1) Safety Sheet for the PEL

(1) Safety Sheet for the MiniFlex® Sensors

(1) Compliance Sheet

(1) SD-Card

(1) Quick Start User Guide

(1) Battery (NiMH AAA 8.4 V) - Cat. #2137.81



(12) ID Markers
Cat. #2140.45

Control Features

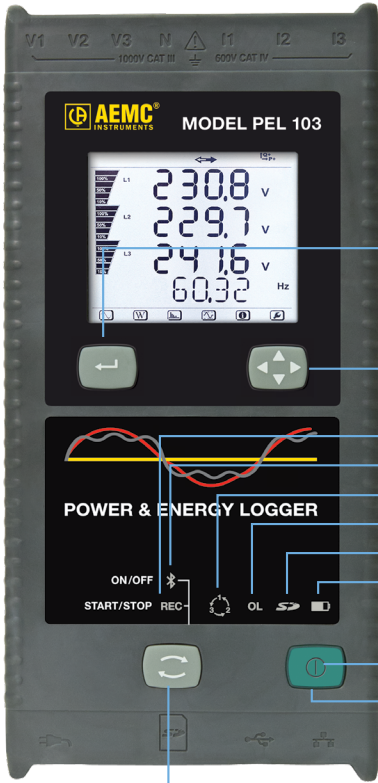

PEL 103

CONTROL BUTTON:

Starts/stops the recording session and enables/disables Bluetooth.

The function is obtained by a 2 s press on the **CONTROL** button, which causes the lighting of the REC LED for 3 s followed by the Bluetooth LED, in sequence.

REC LED (START/STOP)

- A release while lit starts recording (if stopped)
- A release while lit stops recording (if started)

BLUETOOTH LED (ON/OFF)

- A release while lit enables Bluetooth (if disabled)
- A release while lit disables Bluetooth (if enabled)

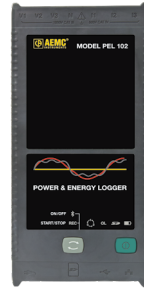

PEL 102

Same features as the PEL 103 without the LCD, Enter or Navigation buttons.

ENTER BUTTON

(PEL 103 Only):

Provides additional measurement quantities for the currently-viewed display.

NAVIGATION BUTTON

(PEL 103 Only):

Enables browsing and the selection of displayed data.

ON/OFF BUTTON:

- To turn ON: Connect the power cord into an AC outlet.
- To turn OFF: Disconnect the power cord from the AC outlet, then press the ON/OFF button for >2 s.

NOTE: The instrument cannot be turned OFF while connected to an AC outlet or if a recording is in progress.

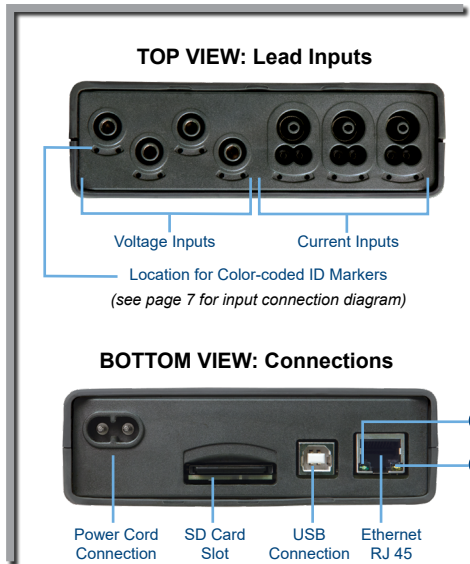

TOP VIEW: Lead Inputs

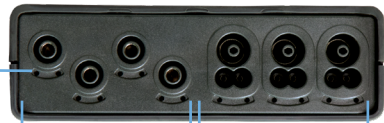

Voltage Inputs

Current Inputs

Location for Color-coded ID Markers

(see page 7 for input connection diagram)

BOTTOM VIEW: Connections



Power Cord Connection

SD Card Slot

USB Connection

Ethernet RJ 45

LED Status

LED	STATUS
①	Green LED: Recording Status <ul style="list-style-type: none"> - LED blinks once per second every 5 s: Logger in standby (not recording) - LED blinks twice per second every 5 s: Logger in recording mode
②	Blue LED: Bluetooth <ul style="list-style-type: none"> - LED OFF: Bluetooth OFF (disabled) - LED ON: Bluetooth ON (enabled - not transmitting) - LED blinks twice per second: Bluetooth ON (enabled - transmitting)
③	Red LED: Phase Order <ul style="list-style-type: none"> - OFF: Phase rotation order correct - LED blinks once per second: Phase rotation order incorrect
④	Red LED: Overload <ul style="list-style-type: none"> - OFF: No input overload - LED blinks once per second: At least one input is in overload - LED ON: Indicates a current probe is either mismatched or missing
⑤	Red/Green LED: SD-Card Status <ul style="list-style-type: none"> - Green LED ON: SD-Card is OK - Red LED blinks five times every 5 s: SD-Card is full - Red LED blinks four times every 5 s: less than 1 week capacity remaining - Red LED blinks three times every 5 s: less than 2 weeks capacity remaining - Red LED blinks twice every 5 s: less than 3 weeks capacity remaining - Red LED blinks once every 5 s: less than 4 weeks capacity remaining - Red LED ON: SD-Card is not present or locked
⑥	Yellow/Red LED: Battery Status <ul style="list-style-type: none"> - When the AC power cord is connected, the battery charges until it is full - LED OFF: Battery full (with or without power supply) - Yellow LED ON: Battery is charging - Yellow LED blinks once per second: Battery is recovering from a full discharge - Red LED blinks twice per second: Low battery (and no power supply)
⑦ <i>under ON/OFF button</i>	Green LED: ON/OFF <ul style="list-style-type: none"> - LED ON: External power supply present - LED OFF: No external power supply
⑧ <i>embedded in the connector</i>	Green LED: Ethernet <ul style="list-style-type: none"> - LED OFF: No activity - LED blinking: Activity
⑨ <i>embedded in the connector</i>	Yellow LED: Ethernet <ul style="list-style-type: none"> - LED OFF: The stack failed to initialize or Ethernet controller failed to initialize - Blink Slow, toggle every second: The stack initialized properly - Blink Fast, toggle 10 times per second: The Ethernet controller initialized properly - Blink Twice, toggle 2 times, then pause: DHCP Error - LED ON: Network initialized and ready for use

Installing DataView®



NOTE: DO NOT CONNECT THE INSTRUMENT TO THE PC BEFORE INSTALLING THE SOFTWARE AND DRIVERS.

1. Insert the USB stick into an available USB port (wait for driver to be installed).
2. If Autorun is enabled, an AutoPlay window should appear. If Autorun is disabled, it will be necessary to open Windows Explorer, then locate and open the USB stick drive labeled "DataView" to view the files on the drive.
3. In the AutoPlay window, select "Open folder to view files".
4. Double-click on Setup.exe from the opened folder view to launch the DataView® setup program.



NOTE: For more information on using the DataView® software, refer to the Power Energy Logger (PEL) user manual that is supplied on the USB stick.



SD-Card

Insert the supplied SD-Card into the PEL.

SD-Cards up to 32 GB are supported.

Hot extraction is possible when not recording.

Opening the PEL Control Panel in DataView®

- Connect the power cord to an AC outlet. The instrument will power on.
- Connect the supplied USB cable to the PEL and the PC. Wait for the drivers to finish installing before proceeding.
- Double-click the DataView folder located on your desktop
- Double-click the PEL icon  located in the DataView folder to open the PEL Control Panel.
- Select the **Add an Instrument** icon  from the toolbar or the main **Instrument** menu.
- Follow the instructions from the **Add an Instrument** wizard. If the Control Panel cannot locate the instrument in the drop-down list, click on the Refresh button, or disconnect and reconnect the USB cable.
- When a connection to the instrument has been established, the instrument's name should appear along the left side of the Control Panel within the **PEL Network**.

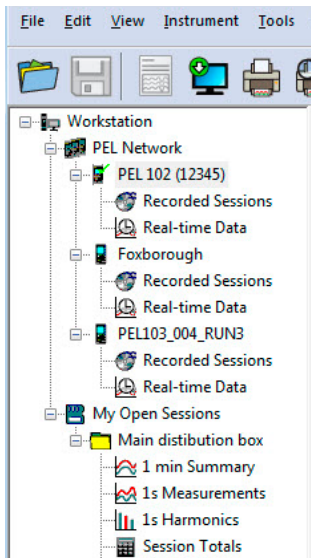

Example of the PEL Network within the Control Panel.

Configuring the Instrument

To configure the PEL, select the instrument in the PEL Network branch.

Open the Configure Instrument dialog box from the Configure icon  on the toolbar, the Instrument menu, or the Status frame.

This dialog box consists of six tabs:

- **General:** Provides instrument labeling fields, auto power off control, LCD control, operation button control, set clock and format SD card options.
- **Communication:** Options for Bluetooth and LAN connections.
- **Measurement:** Distribution system selection, voltage ratio, frequency selection and setting for current sensors.
- **Current Sensors:** Options for configuring sensors and probes connected to the instrument
- **Recording:** Options for selecting recording parameters.
- **Meters:** Resets meters and options for partial energy reset periods.

Click on the  button to transfer the new configuration to the instrument.

Installation of the Leads and Current Sensors

Twelve sets of color-coded rings and inserts are supplied with your PEL instrument. Use these ID markers to identify the leads and input terminals.

- Detach the appropriate inserts from the color-coded marker and place them in the holes provided under the terminals (larger inserts for current terminals, smaller inserts for voltage terminals).
- Clip the rings of the same color to the ends of the lead you will be connecting to the terminal.

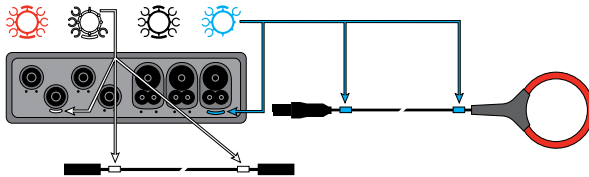

Connect the measuring leads to your PEL as follows:

- Current measurement: I1, I2, I3 4-pin connectors
- Voltage measurement: V1, V2, V3 and N terminals

The measuring leads must be connected to the circuit to be monitored according to the selected hook-up diagram. Do not forget to define the transformer ratio when necessary.

Mounting

The PEL is equipped with integrated magnets on the back panel used for mounting to a magnetic surface.



Setting a Recording (Start/Stop)

To start a recording, perform one of the following:

- In the PEL Control Panel: Select the option from the Recording tab of the Configuration dialog box. The instrument can be configured to start a recording either at a future date/time or immediately upon writing the configuration to the instrument.
- On the Instrument: Press and hold the CONTROL button  until the Green LED lights, then release the control button. This starts the instrument recording using the previous configuration settings.

To stop a recording, perform one of the following:

- In the PEL Control Panel: From the menu, select Instrument >  Stop Recording.
- On the Instrument: Press and hold the CONTROL button until the Green LED lights, then release the control button.

Viewing the Recording

Recorded data can be transferred to the PC for viewing and report generation in one of two ways:

- The SD card can be removed from the instrument and connected to the PC via the supplied SD-card reader. Start the PEL Control Panel, select the Open command from the File menu, point to the icp file with the desired session number on the SD card and select Open.
- Direct connection between the PC and the PEL (USB, Network or Bluetooth). Start the PEL Control Panel, open a connection to the instrument, select the instrument (be sure the instrument is connected) in the tree view and select Recorded Sessions. Double-click on the desired recording session.

When downloading is complete, select the downloaded test and click the Open button in the Download dialog box.

In both cases, the session is added to My Open Sessions in the PEL Network. Data can now be viewed.

DISTRIBUTION SYSTEMS AND PEL HOOK-UPS



NOTE: Ensure that the current arrow on the sensor is directed towards the load. This ensures proper phase angle for power measurements and other phase sensitive measurements.

Single Phase 2-Wire

- Connect the terminal N test lead to Neutral
- Connect the terminal V1 test lead to L1
- Connect the current probe to L1

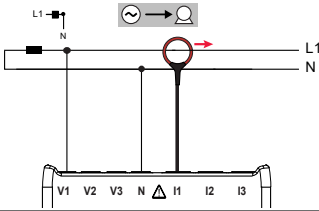

Single Phase 3-Wire

- Connect the terminal N test lead to Neutral
- Connect the terminal V1 test lead to L1
- Connect the terminal V2 test lead to L2
- Connect the terminal I1 current probe to L1
- Connect the terminal I2 current probe to L2

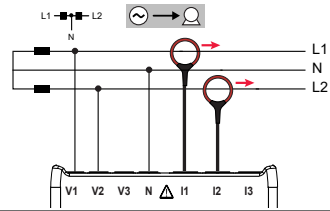

3-Phase 3-Wire Δ (2 current sensors)

- Connect the terminal V1 test lead to L1
- Connect the terminal V2 test lead to L2
- Connect the terminal V3 test lead to L3
- Connect the terminal I1 current probe to L1
- Connect the terminal I3 current probe to L3

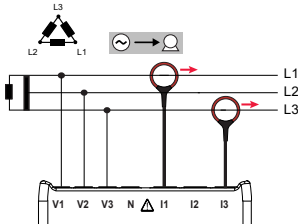

3-Phase 3-Wire Δ (3 current sensors)

- Connect the terminal V1 test lead to L1
- Connect the terminal V2 test lead to L2
- Connect the terminal V3 test lead to L3
- Connect the terminal I1 current probe to L1
- Connect the terminal I2 current probe to L2
- Connect the terminal I3 current probe to L3

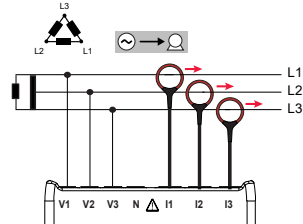

3-Phase 3-Wire Open Δ (2 current sensors)

- Connect the terminal V1 test lead to L1
- Connect the terminal V2 test lead to L2
- Connect the terminal V3 test lead to L3
- Connect the terminal I1 current probe to L1
- Connect the terminal I3 current probe to L3

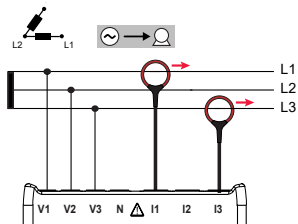

3-Phase 3-Wire Open Δ (3 current sensors)

- Connect the terminal V1 test lead to L1
- Connect the terminal V2 test lead to L2
- Connect the terminal V3 test lead to L3
- Connect the terminal I1 current probe to L1
- Connect the terminal I2 current probe to L2
- Connect the terminal I3 current probe to L3

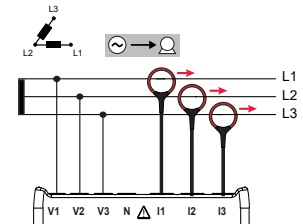



NOTE: Ensure that the current arrow on the sensor is directed towards the load. This ensures proper phase angle for power measurements and other phase sensitive measurements.

3-Phase 3-Wire Y (2 current sensors)

- Connect the terminal V1 test lead to L1
- Connect the terminal V2 test lead to L2
- Connect the terminal V3 test lead to L3
- Connect the terminal I1 current probe to L1
- Connect the terminal I3 current probe to L3

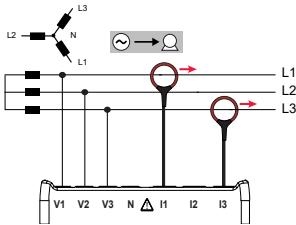

3-Phase 3-Wire Y (3 current sensors)

- Connect the terminal V1 test lead to L1
- Connect the terminal V2 test lead to L2
- Connect the terminal V3 test lead to L3
- Connect the terminal I1 current probe to L1
- Connect the terminal I2 current probe to L2
- Connect the terminal I3 current probe to L3

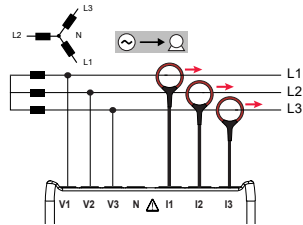

3-Phase 3-Wire Δ Balanced (1 current sensor)

- Connect the terminal V1 test lead to L1
- Connect the terminal V2 test lead to L2
- Connect the terminal I3 current probe to L3

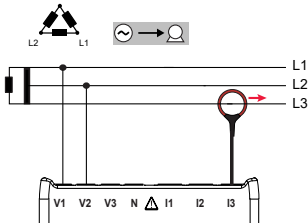

3-Phase 4-Wire Y (3 current sensors)

- Connect the terminal N test lead to Neutral
- Connect the terminal V1 test lead to L1
- Connect the terminal V2 test lead to L2
- Connect the terminal V3 test lead to L3
- Connect the terminal I1 current probe to L1
- Connect the terminal I2 current probe to L2
- Connect the terminal I3 current probe to L3

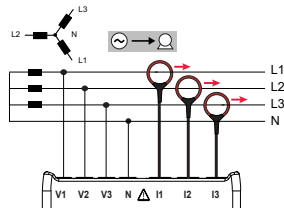

3-Phase 4-Wire Y Balanced

- Connect the terminal N test lead to Neutral
- Connect the terminal V1 test lead to L1
- Connect the terminal I1 current probe to L1

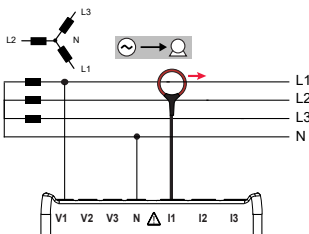

3-Phase 4-Wire Y $2\frac{1}{2}$ Element

- Connect the terminal N test lead to Neutral
- Connect the terminal V1 test lead to L1
- Connect the terminal V3 test lead to L3
- Connect the terminal I1 current probe to L1
- Connect the terminal I2 current probe to L2
- Connect the terminal I3 current probe to L3

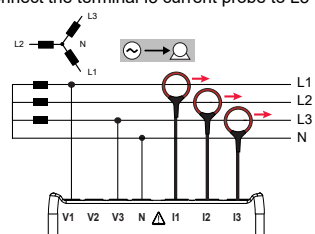



NOTE: Ensure that the current arrow on the sensor is directed towards the load. This ensures proper phase angle for power measurements and other phase sensitive measurements.

3-Phase 4-Wire Δ

- Connect the terminal N test lead to Neutral
- Connect the terminal V1 test lead to L1
- Connect the terminal V2 test lead to L2
- Connect the terminal V3 test lead to L3
- Connect the terminal I1 current probe to L1
- Connect the terminal I2 current probe to L2
- Connect the terminal I3 current probe to L3

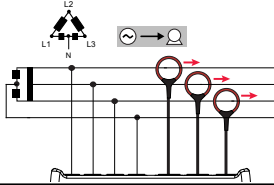

3-Phase 4-Wire Open Δ

- Connect the terminal N test lead to Neutral
- Connect the terminal V1 test lead to L1
- Connect the terminal V2 test lead to L2
- Connect the terminal V3 test lead to L3
- Connect the terminal I1 current probe to L1
- Connect the terminal I2 current probe to L2
- Connect the terminal I3 current probe to L3

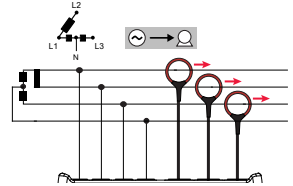

DC 2-Wire

- Connect the terminal N lead to the common conductor
- Connect the terminal V1 test lead to conductor +1
- Connect the terminal I1 current probe to conductor +1

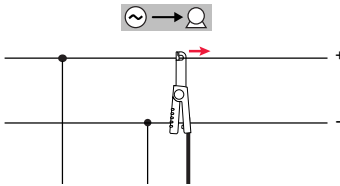

DC 3-Wire

- Connect the terminal N lead to the common conductor
- Connect the terminal V1 test lead to conductor +1
- Connect the terminal V2 test lead to conductor +2
- Connect the terminal I1 current probe to conductor +1
- Connect the terminal I2 current probe to conductor +2

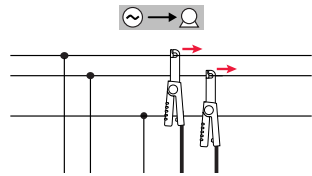

DC 4-Wire

- Connect the terminal N lead to the common conductor
- Connect the terminal V1 test lead to conductor +1
- Connect the terminal V2 test lead to conductor +2
- Connect the terminal V3 test lead to conductor +3
- Connect the terminal I1 current probe to conductor +1
- Connect the terminal I2 current probe to conductor +2
- Connect the terminal I3 current probe to conductor +3

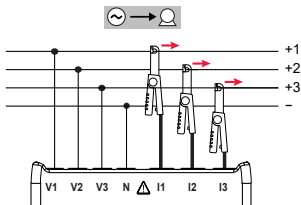

Repair and Calibration

To ensure that your instrument meets factory specifications, we recommend that it be sent back to our factory Service Center at one-year intervals for recalibration or as required by other standards or internal procedures.

For instrument repair and calibration:

You must contact our Service Center for a Customer Service Authorization Number (CSA#). Send an email to repair@aemc.com requesting a CSA#, you will be provided a CSA Form and other required paperwork along with the next steps to complete the request. Then return the instrument along with the signed CSA Form. This will ensure that when your instrument arrives, it will be tracked and processed promptly. Please write the CSA# on the outside of the shipping container. If the instrument is returned for calibration, we need to know if you want a standard calibration or a calibration traceable to N.I.S.T. (includes calibration certificate plus recorded calibration data).

Ship To: Chauvin Arnoux®, Inc. d.b.a. AEMC® Instruments
15 Faraday Drive ▪ Dover, NH 03820 USA
Phone: (800) 945-2362 (Ext. 360) / (603) 749-6434 (Ext. 360)
Fax: (603) 742-2346
E-mail: repair@aemc.com

(Or contact your authorized distributor.)

Contact us for the costs for repair, standard calibration, and calibration traceable to N.I.S.T.



NOTE: You must obtain a CSA# before returning any instrument.

Technical and Sales Assistance

If you are experiencing any technical problems or require any assistance with the proper operation or application of your instrument, please call, e-mail or fax our technical support team:

Chauvin Arnoux®, Inc. d.b.a. AEMC® Instruments
Phone: (800) 343-1391 (Ext. 351)
Fax: (603) 742-2346
E-mail: techsupport@aemc.com
www.aemc.com

Limited Warranty

The instrument is warranted to the owner for a period of two years from the date of original purchase against defects in manufacture. This limited warranty is given by AEMC® Instruments, not by the distributor from whom it was purchased. This warranty is void if the unit has been tampered with, abused, or if the defect is related to service not performed by AEMC® Instruments.

Full warranty coverage and product registration is available on our website at www.aemc.com/warranty.html.

Please print the online Warranty Coverage Information for your records.

What AEMC® Instruments will do:

If a malfunction occurs within the warranty period, you may return the instrument to us for repair, provided we have your warranty registration information on file or a proof of purchase. AEMC® Instruments will repair or replace the faulty material at our discretion.

REGISTER ONLINE AT: www.aemc.com/warranty.html

Warranty Repairs

What you must do to return an Instrument for Warranty Repair:

First, send an email to repair@aemc.com requesting a Customer Service Authorization Number (CSA#) from our Service Department. You will be provided a CSA Form and other required paperwork along with the next steps to complete the request. Then return the instrument along with the signed CSA Form. Please write the CSA# on the outside of the shipping container. Return the instrument, postage or shipment pre-paid to:

Chauvin Arnoux®, Inc. d.b.a. AEMC® Instruments
15 Faraday Drive, Dover, NH 03820 USA
Phone: (800) 945-2362 (Ext. 360)
(603) 749-6434 (Ext. 360)
Fax: (603) 742-2346
E-mail: repair@aemc.com

Caution: To protect yourself against in-transit loss, we recommend that you insure your returned material.



NOTE: You must obtain a CSA# before returning any instrument.

Quick Start Guide Translations

Visit our website to view and download a PDF version of this Quick Start Guide:

Español



Français



NOTES:

NOTES:



08/23
99-MAN 100372 v11

AEMC® Instruments
15 Faraday Drive • Dover, NH 03820 USA
Phone: (603) 749-6434 • (800) 343-1391 • Fax: (603) 742-2346
www.aemc.com
